

Magn. Formkenngrößen  
*eff. magn. parameters*

Formfaktor <i>core factor</i>	$C_1 =$	0,94 mm <sup>-1</sup>
Eff. magn. Weglänge <i>eff. magn. path length</i>	$l_e =$	89,7 mm
Eff. magn. Querschnitt <i>eff. magn. cross section</i>	$A_e =$	95,7 mm <sup>2</sup>
Eff. magn. Volumen <i>eff. magn. volume</i>	$V_e =$	8580 mm <sup>3</sup>
Gewicht <i>weight</i>	$G \approx$	41 g

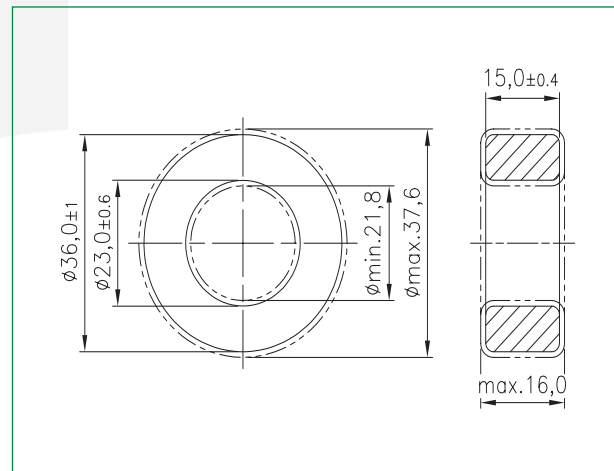

Werkstoff material	$A_L$ -Wert $A_L$ value nH	Toleranz tolerance		Bestellnummer order number <sup>*)</sup>
		unbeschichtet <i>uncoated</i>	beschichtet <i>coated</i>	
K 2006	2800	± 25%	± 25%	xxx 362315 026
K 4000	5350	± 25%	± 25%	xxx 362315 004
K 5500	6700	± 25%	± 25%	xxx 362315 055
K 6000	8050	± 25%	± 30%	xxx 362315 006
K 7000	8700	± 25%	± 30%	xxx 362315 007

<sup>\*)</sup> xxx steht für / *xxx stands for* 317: Epoxylackbeschichtung / *epoxy lacquer coating*  
 318: unbeschichtet / *uncoated*

Weitere Materialien und Höhen auf Anfrage / *further materials and heights on request*

*All information given without liability. If you require further information about our products, do not hesitate to contact our representatives, or visit our homepage, [www.kaschke.de](http://www.kaschke.de).*

**Kaschke Components GmbH**

Rudolf-Winkel-Straße 6 · 37079 Göttingen · Germany  
 Fon +49 (0) 551-5058-6 · Fax +49 (0) 551-65756  
[kaschke.de](http://kaschke.de)