

Magn. Formkenngrößen
eff. magn. parameters

Formfaktor <i>core factor</i>	$C_1 =$	1,00 mm ⁻¹
Eff. magn. Weglänge <i>eff. magn. path length</i>	$l_e =$	152 mm
Eff. magn. Querschnitt <i>eff. magn. cross section</i>	$A_e =$	153 mm ²
Eff. magn. Volumen <i>eff. magn. volume</i>	$V_e =$	23260 mm ³
Gewicht <i>weight</i>	$G \approx$	112 g

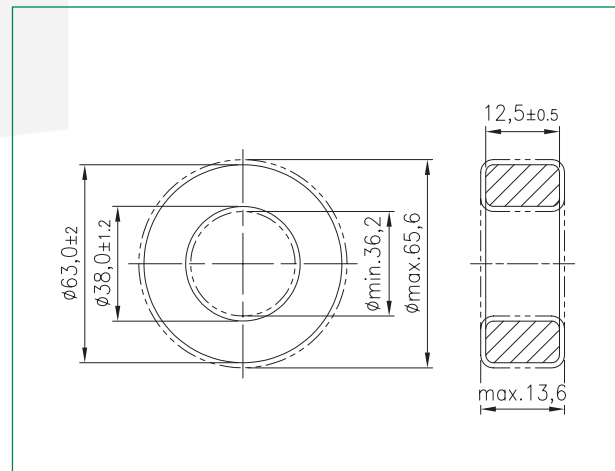

Werkstoff material	A_L -Wert A_L value nH	Toleranz tolerance		Bestellnummer order number ^{*)}
		unbeschichtet <i>uncoated</i>	beschichtet <i>coated</i>	
K 2006	2650	± 25%	± 25%	xxx 633812 026
K 4000	5050	± 25%	± 25%	xxx 633812 004
K 5500	6300	± 25%	± 25%	xxx 633812 055
K 6000	7550	± 25%	± 30%	xxx 633812 006
K 7000	8200	± 25%	± 30%	xxx 633812 007

^{*)} xxx steht für / *xxx stands for* 317: Epoxylackbeschichtung / *epoxy lacquer coating*
 318: unbeschichtet / *uncoated*

Weitere Materialien und Höhen auf Anfrage / *further materials and heights on request*

All information given without liability. If you require further information about our products, do not hesitate to contact our representatives, or visit our homepage, www.kaschke.de.

Kaschke Components GmbH

Rudolf-Winkel-Straße 6 · 37079 Göttingen · Germany
 Fon +49 (0) 551-5058-6 · Fax +49 (0) 551-65756
kaschke.de